

# LTECH

## UX8 TOUCH PANEL (RGBW)



Manual

[www.ltech-led.com](http://www.ltech-led.com)

## Technical Specs

### UX8 RGBW Touch Panel

|                |                                      |
|----------------|--------------------------------------|
| Input Voltage: | 5Vdc, 0.5A-1A (with a power adapter) |
| Output Signal: | RF 2.4GHz, DMX512                    |
| Control Mode:  | RGBW, 4 Zones Control                |
| Working Temp.: | -30°C~55°C                           |
| Package Size:  | L132×W192×H50(mm)                    |
| Weight(N.W.):  | 230g                                 |
| Weight(G.W.):  | 370g                                 |

### R4-5A Constant Voltage Receiver (receiver is sold separately)

|                  |                                 |
|------------------|---------------------------------|
| Input Voltage:   | 5-24Vdc                         |
| Current Load:    | 5A × 4CH Max. 20A               |
| Output Power:    | Max. 100W/240W/480W(5V/12V/24V) |
| Wireless Signal: | RF 2.4GHz                       |
| Working Temp.:   | -30°C~55°C                      |
| Package Size:    | L178×W48×H33(mm)                |
| Weight(G.W.):    | 150g                            |

### R4-CC Constant Current Receiver (receiver is sold separately)

|                  |                            |
|------------------|----------------------------|
| Input Voltage:   | 12-48Vdc                   |
| Output Voltage:  | 3-46Vdc                    |
| Output Current:  | CC 350/700/1050mA×4CH      |
| Output Power:    | 1.05W-48.3W×4CH Max 193.2W |
| Wireless Signal: | RF 2.4GHz                  |
| Working Temp.:   | -30°C~55°C                 |
| Package Size:    | L178×W48×H33(mm)           |
| Weight(G.W.):    | 165g                       |



## Product Size:

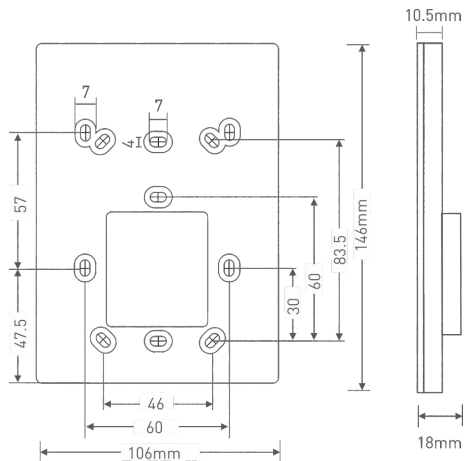

UX8 Touch Panel

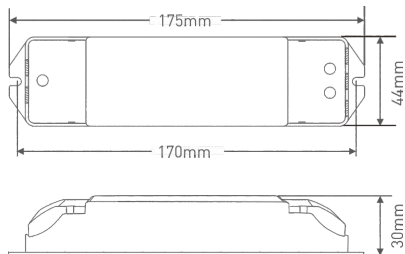

R4-5A/R4-CC Receiver

## Terminals

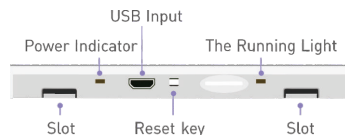
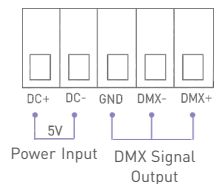
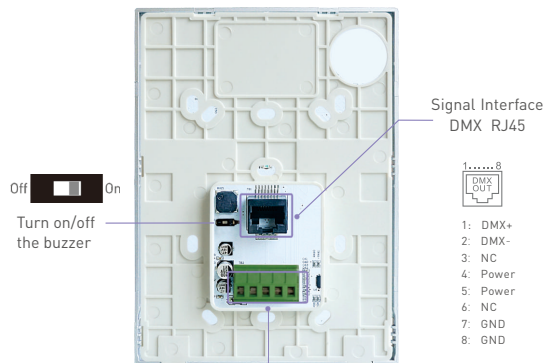

## Installation Instruction:

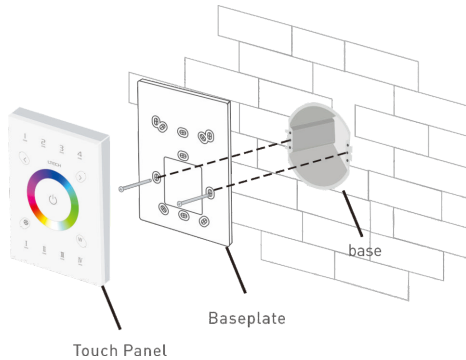

1. Install the back box into the wall. Typical boxes as below:

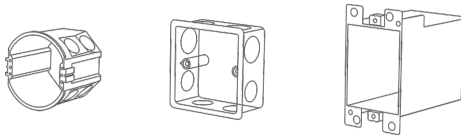

2. Use a straight screwdriver to pry the position shown:

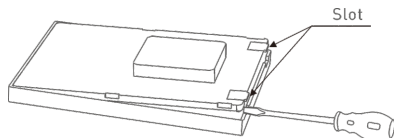

3. screw the baseplate and the back box in the wall firmly.

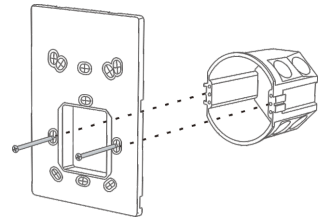

4. Connect in a right way and put the power adapter into the back box.

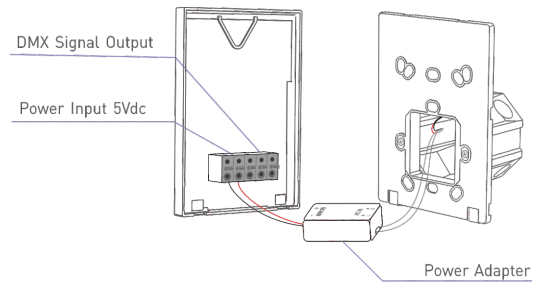

- 5 Embed the upper touch panel into the baseplate and then tap the bottom to press into the slots.

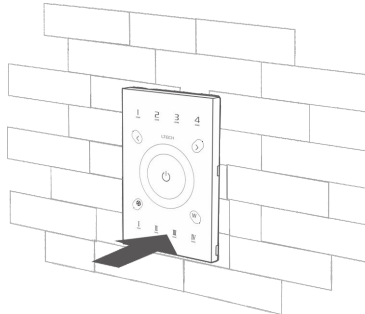
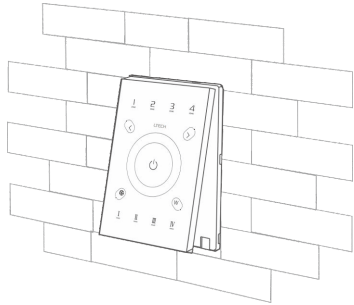

## Key Functions

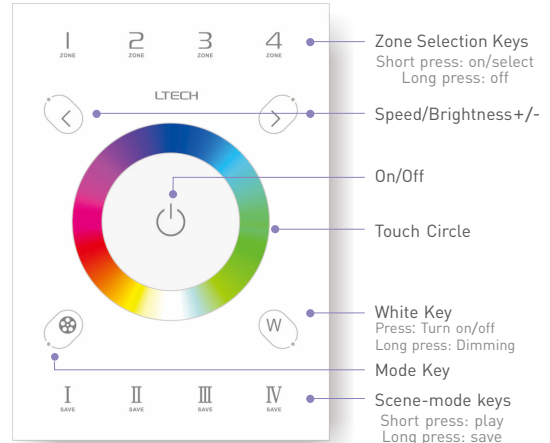

### The Changing Mode (Press to Select):

1. Static Red
2. Static Green
3. Static Blue
4. Static Yellow
5. Static Purple
6. Static Cyan
7. Static White
8. RGB Jumping
9. 7 Colors Jumping
10. RGB Smooth
11. 7 Colors Smooth
12. Static Black

## Application Composition

### DMX512 Signal Output :

1. Touch panel (UX8)
2. + Remote (V8)
3. + WiFi master controller (WiFi-104)
4. + WiFi master controller (WiFi-104) + Remote (V8)

### Wireless Control:

1. + Wireless receiver (R4-3A/5A, R4-CC)
2. + Remote (V8) + Wireless receiver (R4-3A/5A, R4-CC)
3. + WiFi master controller (WiFi-104) + Wireless receiver (R4-3A/5A, R4-CC)
4. + WiFi master controller (WiFi-104) + Remote (V8) + Wireless receiver (R4-3A/5A, R4-CC)

## DMX Output Wiring

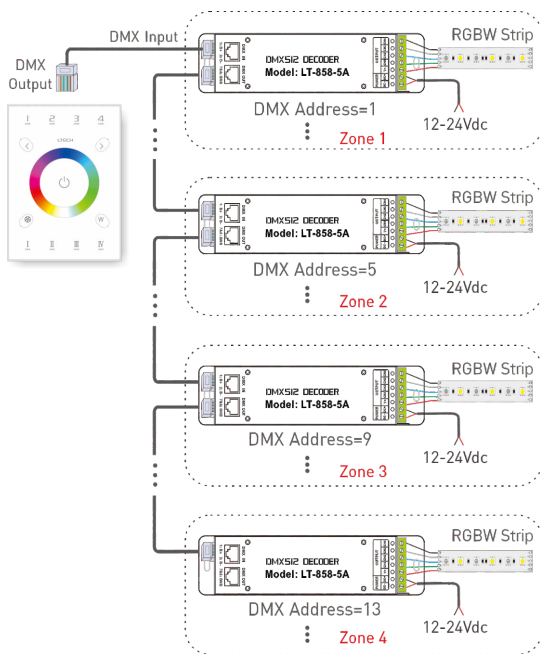

## RF Wireless Wiring

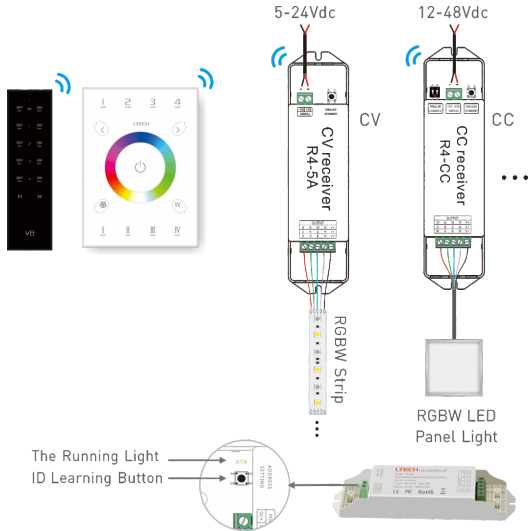

### Match / Clear Code between UX8 (V8) & Receivers

#### Match Code:

Short press "ID learning button" on receiver (R4-3A/5A, R4-CC), then press any zone key on UX8 or V8, if the LEDs flicker once, match successfully.

#### Clear Code:

Long press "ID learning button" on receiver (R4-3A/5A, R4-CC) for 5 seconds, if the LEDs flicker twice, deactivate the matching successfully.

## DMX System Wiring

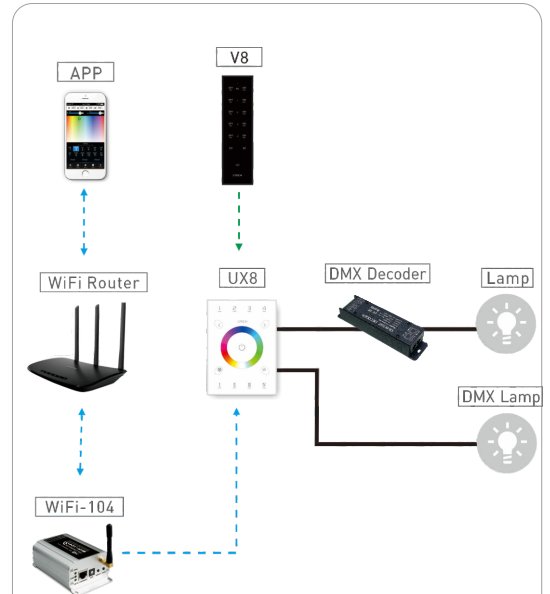

### Match Code Sequence

1. Configure WiFi-104 with UX8, which enables the smart phone to control DMX device via WiFi-104.
2. Configure V8 with UX8, which enables V8 to control DMX device.

## Wireless System Wiring

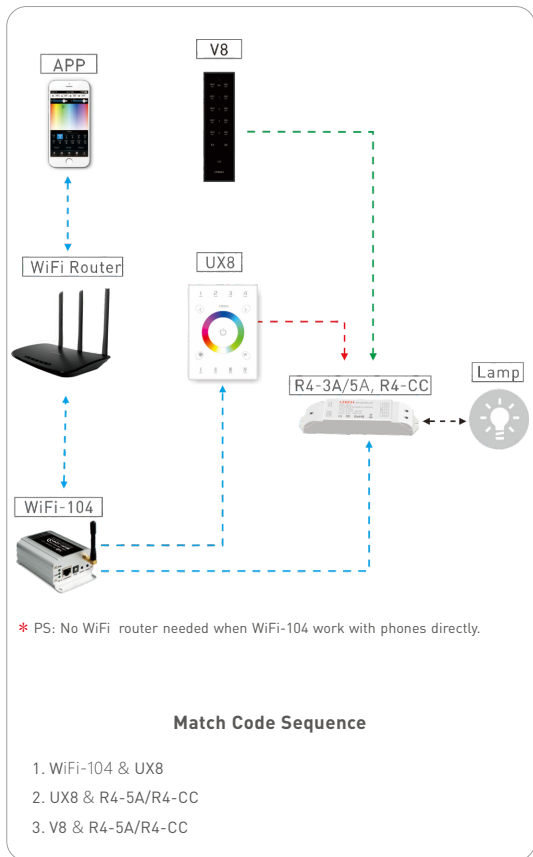

## Match / Clear Code for UX8 & WiFi-104, V8, UX8

### Match Code:

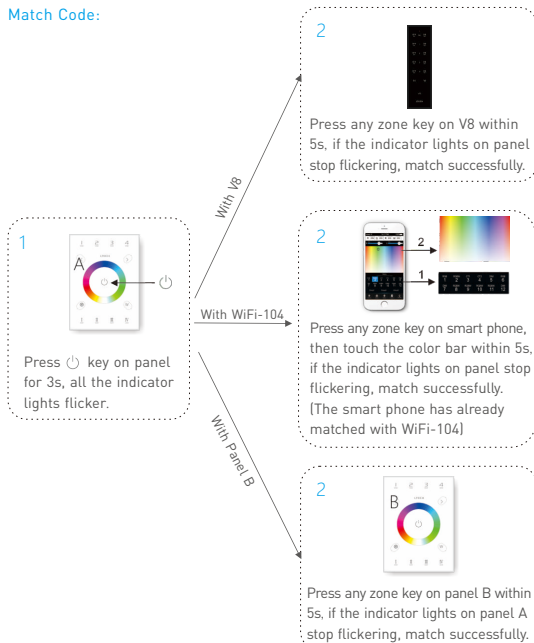

### Clear Code:

